

User Manual

impression[®]
E 350



Software v. 28-40-31-27



GLP® impression E350 User Manual Revision A

This user manual covers fixture software version v. 28-40-31-27

© 2018 German Light Products GmbH. All rights reserved.

The marks 'GLP', 'German Light Products' and 'impression' are trademarks registered as the property of German Light Products GmbH in Germany, in the United States of America and in other countries.

The information contained in this document is subject to change without notice. German Light Products GmbH and all affiliated companies disclaim liability for any injury, damage, direct or indirect loss, consequential or economic loss or any other loss occasioned by the use of, inability to use or reliance on the information contained in this document.

Manufacturer head office:

German Light Products GmbH (GLP), Industriestrasse 2, 76307 Karlsbad, Germany

Tel (Germany): +49 7248 92719 - 0

Service & Support EMEA:

GLP, Industriestrasse 2, 76307 Karlsbad, Germany

Tel. (Germany): +49 7248 9271955

Email: support@glp.de

www.glp.de

Service & Support USA:

GLP USA, 1145 Arroyo St., Ste. A, 91340 San Fernando, California

Tel (USA): +1 818 767 8899

Support (US): info@germanlightproducts.com

www.germanlightproducts.com

Contents

1. Safety	4
2. Avoiding damage	9
3. Product overview.....	11
4. Product features	12
5. Preparation for use	19
6. Control menus and LCD display	23
7. Control menu layout	25
8. DMX channel layout.....	28
9. Troubleshooting.....	35
10. Caring for your product.....	36
11. Technical specifications	37
12. Dimensions	40

1. Safety

Key to symbols

The following symbols are used in this manual:



Warning! Safety hazard.
Risk of severe injury or death.



Warning! Hazardous voltage.
Risk of lethal or severe electric shock.



Warning! See user manual for important safety information.



Warning! Fire hazard.



Warning! Risk of eye injury.



General safety information

Read this section carefully before installing or using the impression E350 lighting fixture. If you have any doubts or questions about how to use the product safely, contact your GLP® supplier for assistance.

The product and this user manual are intended for use by experienced professionals with the knowledge and skills to set up, operate, and maintain high-powered, remotely controlled lighting equipment safely and efficiently. These operations require expertise that may not be provided in this manual.

- Respect all warnings and directions given in this user manual and on the product. Read this manual and familiarize yourself with the safety precautions it contains before installing or using the product. The manufacturer will take no responsibility for damages or harm resulting from disregard for the information in this manual.
- Check the GLP website at www.glp.de and make sure that you have the latest version of this user manual. Check the fixture software version indicated on page 2 of this user manual and then use the fixture's control panel to check the version installed in the fixture. If the versions are not the same, the user manual may still cover the fixture (software updates do not always affect the way you use the fixture), but it is possible that the manual does not match the fixture perfectly. The software release notes should help clarify this question. You can consult software release notes and download the correct version of this user manual on the GLP website if necessary.

- Make the user manual available to all installers and operators and save the manual for future reference.
- If you have questions about the safe operation of the impression E350, please contact an authorized GLP distributor (see list of distributors at www.glp.de).
- Use the product only as directed in this user manual. Observe all markings in this user manual and on the product.
- Refer any service operation not described in this manual and refer all repairs to a technician authorized by GLP.
- The light source in this product must not be changed by the end user.
- Read and follow the user documentation for all additional equipment.



Electrical safety

- Do not allow the product to come into contact with water or moisture.
- Use only a source of AC mains power that complies with local building and electrical codes and has both overload and ground fault (earth fault) protection.
- Ensure that the product is electrically connected to ground (earth).
- Disconnect the product from AC mains power before carrying out any installation or maintenance work and when the product is not in use.
- Disconnect the product from power immediately if the power plug or any seal, cover, cable, or other component is damaged, defective, deformed, wet or showing signs of overheating. Do not reapply power until the product has been repaired and made safe by a technician authorized by GLP.
- Before using the product, check that all power distribution equipment and cables are in perfect condition and rated for the electrical requirements of all connected devices.
- Use only a Neutrik powerCON TRUE1 cable connector for AC power input at the product's power connector.
- Use minimum 14 AWG or 1.5 mm² power input and relay cables that are minimum 16 A rated and temperature-rated to suit the application. In the USA and Canada the cables must be UL-listed, type SJT or equivalent. In the EU the cables must be type H05VV-F or equivalent.
- The supplied power input cable is rated as follows:
 - US power cable: 16 A, 14 AWG, UL listed, E304117, SJT, 4.9 ft.
 - EU power cable: 16 A, 1.5mm², H05VV-F, 1.5 m
- If a fuse blows, replace it with one of the original type and rating only. If new fuses blow, disconnect the product from power and send it to a technician authorized by GLP for repair.



Fire safety and protection from burns

- Do not operate the product if the ambient temperature (T_a) exceeds 45° C (115° F).
- The surface of the product's casing can reach up to 55° C (131° F) during operation. Avoid contact by persons and materials. Do not install the product in a location where there is a risk of accidental contact. Allow the product to cool for at least 10 minutes before handling.
- Keep the product well away from flammable materials.
- Keep all combustible materials (e.g. fabric, wood, paper) at least 200 mm (8 in.) away from the product.
- Ensure that there is free and unobstructed airflow around the product. Provide a minimum clearance of 100 mm (4 in.) around fans and air vents.
- Do not illuminate surfaces within 2 m (6.6 ft.) of the product.
- Do not install a fuse that has a higher rating than the one originally installed in the product. Do not bypass fuses.
- Do not stick filters, masks or other materials onto optical components.
- If the fixture seems to be abnormally hot, shows signs of melting or emits smoke, disconnect the fixture from power immediately and allow it to cool. Do not touch the fixture without heatproof safety gloves. Keep the fixture well away from combustible and flammable materials.
- The product's optical components can focus the sun's rays, creating a risk of fire and damage. Do not expose the front of the product to sunlight or any other intense light source, even from an angle.



Eye safety

- The impression E350 is classified as a Risk Group 2 product according to DIN EN 62471:2009-03. Possibly hazardous radiation emitted. Do not stare into the light output from the product. May be harmful to the eyes.
- Do not look at the product's light output with optical instruments or any device that may concentrate the light output.
- Make sure that persons working on or near the product are not looking directly into the light output when the product lights up suddenly. This can happen when power is applied, when the product receives a DMX signal, or when certain control menu items are selected.
- Provide well-lit conditions to reduce the pupil diameter of anyone working on or near the product.



Strobe safety

- Flashing light, particularly at 5 - 30 Hz, may cause seizures in persons with photosensitive epilepsy. Do not use strobe effects for extended periods.
- Comply with local regulations on the use of strobe lighting and notify the public in advance with highly visible warning signs when strobe effects are used.
- If a seizure occurs, stop using strobe effects. Seek professional medical help. Note the time that the seizure starts and finishes. Call emergency medical help urgently if the seizure lasts more than five minutes, if it is the person's first seizure, or if the person is injured. While waiting for help to arrive, consider the following general advice for caring for a person who is having a seizure: protect the affected person from injuring themselves on hard or sharp objects. If necessary, move the person to a safe place. Lay them on their side with their head supported to prevent it from hitting the floor. Loosen any tight clothing around their neck. Do not use force to hold the person or restrict their movements. Do not put anything in their mouth, including your fingers.



Installation and operation safety

- The fixture must be installed and operated by qualified personnel only and in accordance with applicable regulations such as DIN VDE 0711-217.
- The fixture is not portable when installed.
- Ensure that the supporting structure and installation hardware used can hold at least 10 times the weight of the load that they support.
- Install the fixture with hardware specifically designed and rated for the purpose. Check that all installation hardware is in perfect condition. Fasteners must be steel grade 8.8 strength or better. Rigging clamps must be half-coupler type that completely encircle the rigging truss chord.
- Screws or bolts used for mounting hardware must protrude minimum 9 mm / 0.36 in. and maximum 11 mm / 0.43 ins. into the threaded holes in the base of the fixture.
- If the fixture is installed in a location where it may cause injury or damage if it falls, install as directed in this manual a safety cable or similar secondary attachment that will hold the product if a primary attachment fails. The secondary attachment must be approved by an official body such as TÜV as a safety attachment for the weight that it secures, it must comply with EN 60598-2-17, and it must be able to support a static suspended load that is ten times the weight that it secures.
- Fasten the fixture to a structure or surface as directed in this user manual. Do not use safety cables as the primary means of support.

- Before applying power to the product, ensure that the moving head can move through its full range without risk of collision. Allow a minimum center-to-center distance of 600 mm / 23.6 in. between fixtures.
- Check that all covers and rigging hardware items are secure.
- Do not operate the product with missing or damaged covers, shields or any optical component.
- Restrict access below the work area and work from a stable platform whenever installing, servicing or moving the product.
- If the product becomes damaged, stop using it immediately and disconnect it from power. Do not attempt to use a product that is obviously damaged.
- Do not modify the product in any way not described in this user manual.
- Install genuine GLP parts only.
- If at any time you see that the product does not conform with one or more of the above safety requirements, disconnect the product from power and secure the affected area until the fixture is installed safely.

2. Avoiding damage

Do not point the front of the fixture towards the sun or other strong light sources. The front lens focuses and concentrates light just like a magnifying glass. Strong light can cause internal damage to the fixture, melting components or starting an internal fire within seconds.

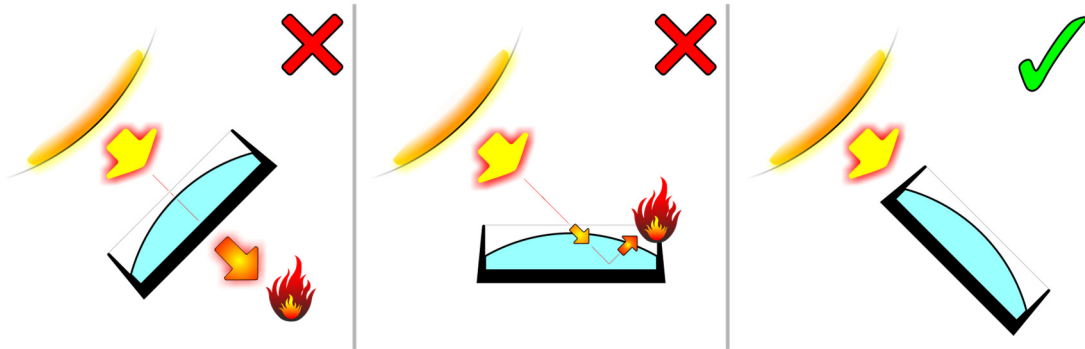

Figure 1. Avoiding damage from light sources

Damage can occur whether the fixture is powered on or off. See Figure 1. Damage can also occur if the light hits the front of the fixture at an angle: the fixture does not need to be pointing *directly* at the sun or other light source.

To avoid problems from strong light sources:

- Do not expose the front of a fixture to sunlight or any other strong light source.
- For outdoor applications during daylight, make sure that the front face of any fixture is shielded or points away from the sun, even when not in use.
- Avoid pointing other high-powered beam lights directly at the fixture.

Do not pick up or carry the fixture by the front lens bezel, as it is not designed to support the weight of the fixture. The LCD display is also fragile. Picking up or supporting the fixture in these places could result in damage that is not covered by the warranty.

Use only original spare parts. Any structural modification of the system will void the product warranty.

Protect the front lens from dirt, dust and other contaminants. Do not touch the front lens. Airborne particles and grease from your fingers can become baked onto the lens and difficult to remove.

Clean optical components only as directed in this manual (see 'Caring for your product' on page 36). Oils, solvents, and other chemicals commonly used for cleaning can damage the lens coatings and surfaces.

Do not drop the product or expose it to mechanical stress.

Do not expose the product to heat (from other lighting fixtures for example).

Transportation and storage

Transport the impression E350 either in a flightcase or in its original packaging to protect the fixture from damage caused by shocks during transportation.

Store the fixture in a dry location where the temperature will remain above 0° C (32° F) when not in use.

Important! Allow the fixture to cool completely and release the tilt lock before packing or transporting the fixture in a flightcase or the original cardboard box.

3. Product overview

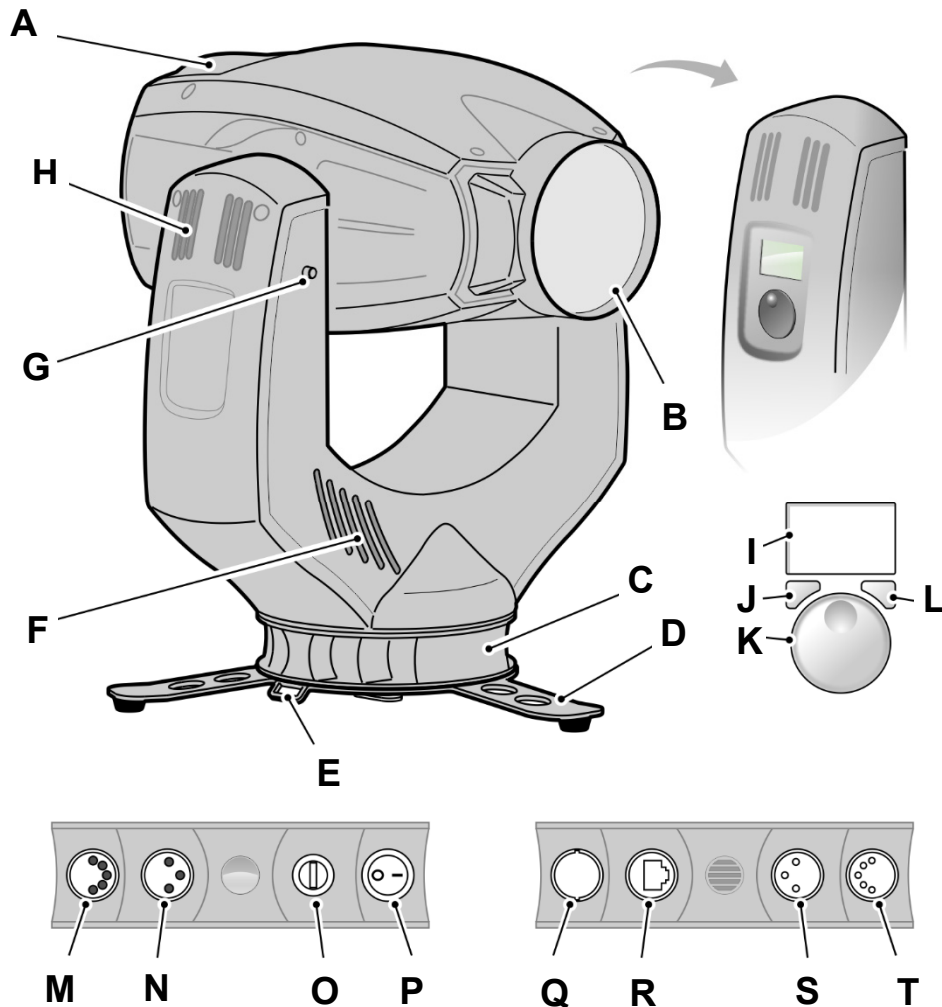

Figure 2: Product overview

- | | |
|---|------------------------------|
| A – Head | K – Jog wheel |
| B – Front glass | L – Enter button |
| C – Mini-base with safety cable attachment points | M – DMX Out (thru) 5-pin XLR |
| D – Tripod stand (supplied) | N – DMX Out (thru) 3-pin XLR |
| E – Stabilizing strap attachment point | O – Fuseholder |
| F – Yoke cooling vents | P – Power On/Off |
| G – Tilt lock | Q – AC mains power In |
| H – Yoke cooling vents | R – Ethernet Port |
| I – Control panel display | S – DMX In 3-pin XLR |
| J – Mode button | T – DMX In 5-pin XLR |

4. Product features

The impression E350 from GLP is a high-quality moving head lighting fixture with a 350W LED engine that provides powerful 7500 K cool white output. The fixture gives impressive hard-edged mid-air effects and bright gobo projections. Advanced German design allows exceptional performance and a versatile feature set to be packed into one of the most compact moving head lighting fixtures currently available, using GLP's familiar 'baseless' format.

Rotating gobos, fixed gobos and a gobo animation wheel give impressive projections and beam effects. A rotating 8-facet prism and a motorized iris add to the impression E350's packed feature set. Precisely engineered optics give a powerful, homogenous and sharply defined beam throughout the fixture's zoom range. Power input via a Neutrik powerCON TRUE1 connector allows hot plugging.

The impression E350 is designed for permanent or temporary indoor use. It can be used outdoors if it is protected from moisture and precautions are taken to prevent damage from direct sunlight. It may be placed upright on a level surface or suspended from a suitable structure as described in this manual.

The impression E350 is not suitable for household use, for use in any location where unattended children have access to it, or for use in permanent outdoor installations.

Light source

The impression E350 is equipped with a 350 W white light 7500 K LED engine with up to 12 200 lumens available and a rated lifetime of 20 000 hours to >70% LED output.

Control panel

The control panel on the side of the yoke has a backlit graphic LCD display for setting up the fixture and changing fixture settings. See 'Control menu layout' on page 25 for a table showing the control menu structure and options available.

Pan and tilt

The impression E350 pans through 640° and tilts through 262°, with coarse and fine control channels and self-correcting position feedback available.

Pan and tilt position feedback can be disabled/enabled using the control panel or the *Special / Control* DMX channel.

The direction of pan and/or tilt movement can be reversed by selecting an *Invert* command using the fixture's control panel or the *Special / Control* DMX channel. Inverting movement is a fast way of obtaining symmetrical effects without reprogramming at the console.

Color

The impression E350 provides 0-100% continuous CMY color mixing and a 10-slot color wheel with ten dichroic color filters including CTC (see Figure 3).

A good method of controlling color is to set CMY levels to 0% when you begin to use the color wheel. Then, after you have selected a color on the color wheel, you can fine tune it using the CMY channels.



Figure 3. Color wheel

CTC

The CTC DMX channel lets you adjust color temperature from 8000 K to 2500 K by deploying the CMY flags. The channel sets the flags into the perfect positions for matching color temperatures on the black body line.

A recommended approach is to set CMY levels to 0% when you begin to use the CTC channel. After you have selected a color temperature on the CTC channel you can fine tune it using the CMY channel.

Rotating gobos

The rotating gobo wheel contains the seven rotating gobos shown below:

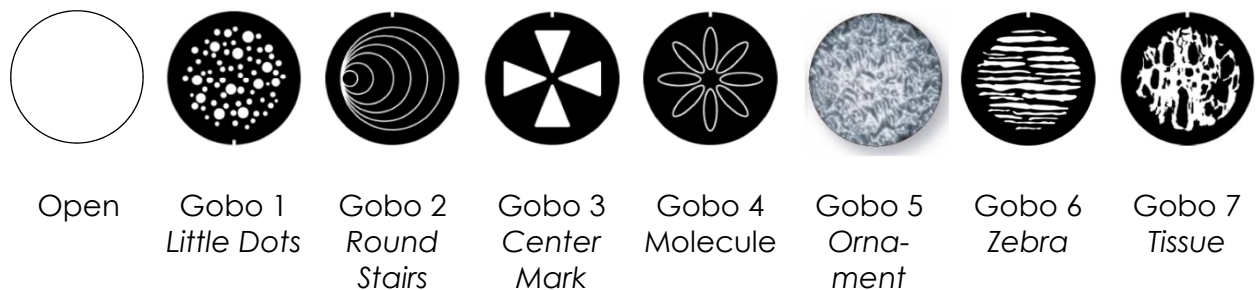

Figure 4. Rotating gobos

You can either select a rotating gobo or set the entire gobo wheel to rotate with variable speed and direction on DMX channel 10. Then you can either set gobo indexed angle or set gobo rotation speed and direction with 16-bit control on channels 11 and 12.

Fixed gobos

The fixed gobo wheel contains the ten fixed gobos shown below:

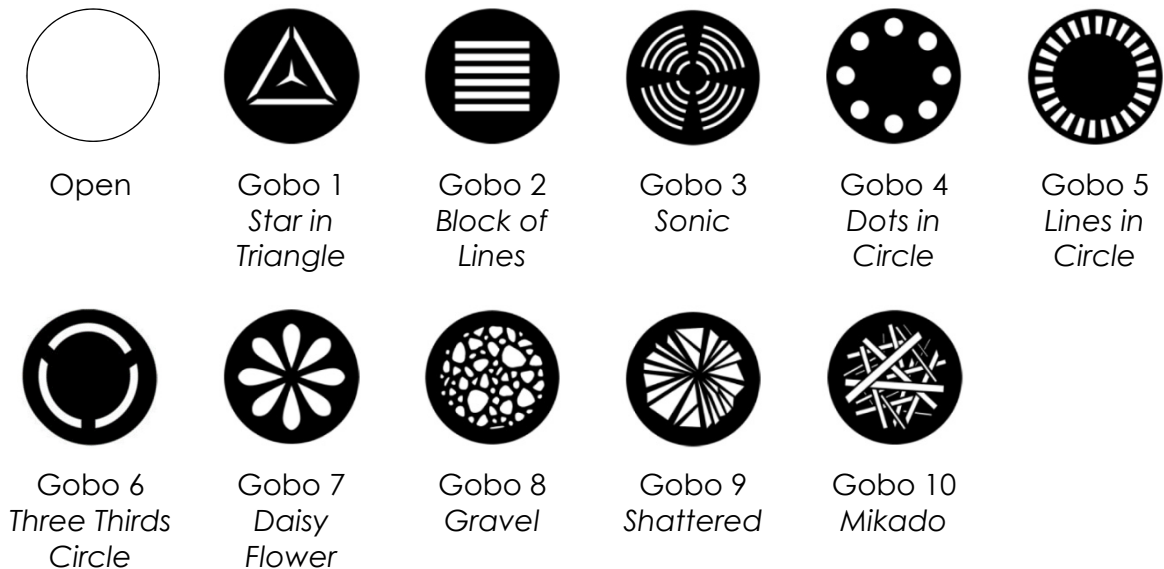

Figure 5. Fixed gobos

You can either select a fixed gobo or set the entire fixed gobo wheel to rotate with variable speed and direction on DMX channel 13.

Animation wheel

You can deploy the animation wheel with the animation profile at continuously variable angles from 0° to 90° to give horizontal, diagonal or vertical animation effects. You can also vary the speed and direction of the animation wheel rotation. When used in combination with static or varying colors, rotating or fixed gobos and frost or focus, the animation wheel makes a huge range of effects possible, from abstract moving patterns to simulated flames, branches in the wind, ripples on water, etc.

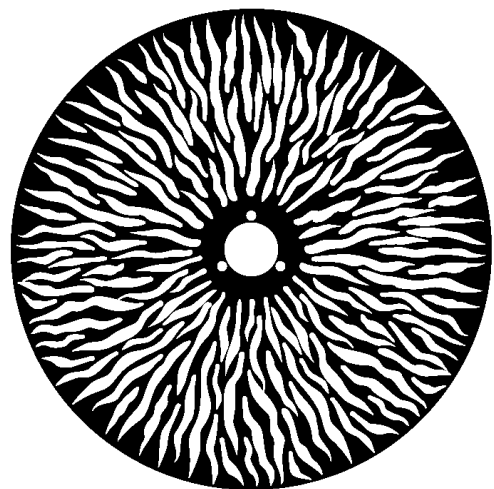

Figure 6. Animation wheel

Frost

The frost system offers two levels of frost effect that can give softer, more diffuse projections: a continuously variable light frost and a continuously variable medium frost.

Iris

The 14-blade iris offers continuous control of the beam diameter, with a very tight open position.

Shutter effects

The impression E350 features an electronic dimmer / shutter system that provides pulse and strobe effects as well as instant open and blackout.

Dimming

0 – 100% continuous dimming is available.

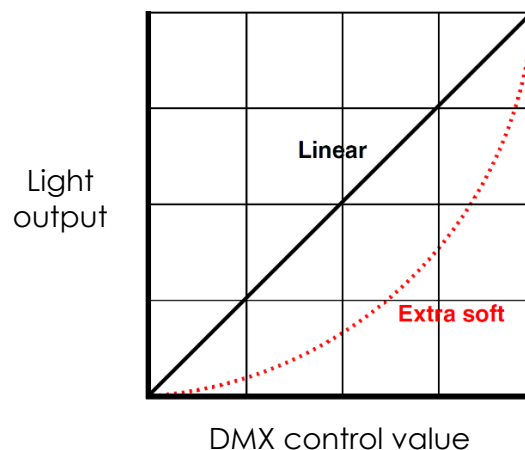

Figure 7. Dimming curves

See Figure 7. You can select from two dimming curves using the control panel or the *Special / Control* DMX channel: **Linear** and **Extra soft**:

- Light output using the **Linear** curve will appear to increase and decrease evenly throughout the dimming range.
- The **Extra soft** curve gives finer control at low light levels (where the eye is more sensitive to changes in light level) and coarser control at high levels.

The default setting is **Extra soft**.

Zoom

The impression E350 has a 1:5 zoom range from 8.5° to 42°.

Control on the Zoom DMX channel can be inverted. Normal control as the DMX value increases is *flood* → *spot*. You can invert this using the control panel and the *Special / Control* DMX channel so that control becomes *spot* → *flood*.

Focus and focus tracking

You can carry out 8-bit focus adjustment on DMX channel 17 and fine 16-bit adjustment on DMX channel 18.

You can also set focus to automatically adjust to match different zoom angles if you enable focus tracking in the fixture's control panel or on the *Special / Control* DMX channel. This feature is useful when zooming in mid-air effects.

Focus tracking can be optimized for three different projection distance ranges. Four focus tracking settings are available:

- **Focus tracking OFF** sets the zoom and focus DMX channels to control zoom and focus completely independently of each other.
- **Focus tracking NEAR** sets focus to automatically adjust for optimum sharpness at projection distances of around 10 meters or less when the zoom angle is changed.
- **Focus tracking MEDIUM** sets focus to automatically adjust for optimum sharpness at projection distances of around 11 - 20 meters when the zoom angle is changed.
- **Focus tracking FAR** sets focus to automatically adjust for optimum sharpness at projection distances of over 20 meters when the zoom angle is changed.

If you have enabled Focus tracking **NEAR**, **MEDIUM** or **FAR** you can still override the automatic focus setting: any manual adjustment that you make on the Focus DMX channel will take priority over the automatic setting. However, if you change the zoom angle again, the fixture will forget any manual focus setting and return to automatically adjusting focus to match the fixture's zoom angle.

Fan modes

The four different cooling fan modes give you a range of options to choose from depending on how you want to allocate priority between high-intensity light output or low fan noise:

- **Fan regulated** gives priority to light output and only operates fans as necessary. If the fixture is blacked out, fans run at minimum speed. When light output intensity is increased, temperature regulation increases fan speed to the level necessary to keep the fixture at optimum temperature.

If light output is set to maximum intensity but the fans can keep the fixture at optimum temperature, there will be no regulation of light intensity. If the fixture begins to exceed optimum temperature, light intensity will be limited until optimum temperature can be maintained.

- **Fan constant high** mode is optimized for maximum light output and suits operation in high ambient temperatures. Fans are set to constant operation at high speed. Light output intensity is limited smoothly if it becomes necessary in order to keep fixture temperature at optimum level.

Besides maximizing light output in high ambient temperatures, you can use this mode to cool down a fixture quickly or to remove dust from cooling fans.

- **Fan constant medium** sets fans to constant operation at medium speed. Light output intensity is reduced to a level where it will normally remain constant at ambient temperatures of up to 45° C (113° F). Intensity is smoothly limited further if it becomes necessary in order to keep fixture temperature at optimum level.
- **Fan constant low** mode sets fans to constant operation at low speed and is optimized for minimum noise. Light output intensity is reduced to a level where it will normally remain constant at ambient temperatures of up to 30° C (86° F). Intensity is smoothly limited further if it becomes necessary in order to keep fixture temperature at optimum level.

In all fan modes, if fixture temperature reaches a dangerous level, LEDs will be shut down for a period until the fans have brought the temperature down to a safe level.

You can set the cooling fan mode using the control panel or the *Special / Control* DMX channel.

Effect wheel shortcuts

By default, the color wheel and gobo wheels take the shortest, fastest route from one slot to the next, even if this means that they may pass through the open position. To avoid the wheels passing through the open position when they change from one slot to the next you can set **Effect shortcuts** on the *Special / Control* DMX channel to **OFF**.

Behavior when the fixture is not receiving a DMX signal

You can set the fixture to react in four different ways if no DMX signal is present (if the fixture is being controlled by DMX but the DMX signal stops, or if you apply power to the fixture when no DMX signal is present):

- **Hold** sets the fixture to continue obeying the last DMX values it received. This is the default setting.
- **Blackout** sets the fixture to black out whenever it is not receiving a DMX signal.
- **Stand-Alone** sets the fixture to play its stored stand-alone scene (see **DMX Shot** below) when the fixture is not receiving a DMX signal. If no stand-alone scene is stored in memory, the fixture will black out.
- **DMX Shot** takes a snapshot of the DMX values that are currently being received and stores them in the fixture's memory as its stand-alone scene. The fixture will display this stand-alone scene if it is set to **Stand-Alone** (see above) and is not receiving a DMX signal.

You can select one of the four settings above using either the control panel or the *Special / Control* DMX channel.

Stand-Alone operation

If the fixture is set to **Stand-Alone** and if a stand-alone scene has been stored in its memory using the **DMX Shot** command, it will display its stand-alone scene at all times when it is powered on but not receiving a DMX signal. You can therefore use this setting if you want fixtures to automatically start stand-alone operation when you apply power to them.

PWM frequency

You can change the LED dimming PWM frequency in order to avoid flicker and beat frequencies in video images. To do this, select a new PWM frequency using either the *Settings* DMX channel or the fixture's control panel.

The default PWM setting is 3000 Hz. You can set the PWM frequency to 2200 Hz, 3000 Hz, 4800 Hz, 9600 Hz or 25 kHz. Note that a higher PWM frequency may affect dimming performance.

The PWM frequency setting is stored in the fixture and is not affected by cycling power off and on. However, it will be affected if you use the Factory default command in the control menus.

As a rule, you should set all the fixtures in an installation to the same PWM frequency in order to ensure the same performance.

Installation options

The base has four Camlock fastener points and two M10 threaded holes for a removable tripod (supplied), omega brackets or direct mounting of half-coupler clamps, allowing various rigging options.

Two eyelets are provided for safety cable attachment.

5. Preparation for use



Warning! Read 'Safety' starting on page 4 for important safety information that you must understand before you install or operate the fixture.

Included Items

The impression E350 is supplied with a power cable with a powerCON TRUE1 connector and a tripod with Camlock fasteners for use as a floor stand.

Orientation and location

The impression E350 may be rigged in any orientation following the instructions in this chapter or placed on a level surface in locations where it is safe to stand the fixture.

Keep the head at least 0.2 m (8 in.) away from combustible materials (including curtains and stage scenery) when the fixture is installed.

Make sure that there is no risk of collision when the head pans and tilts. Allow a minimum center-to-center distance of 600 mm (23.6 in.) when installing impression E350 fixtures side by side.

Mounting fasteners in base

See Figure 8. The base of the impression E350 has two threaded holes **A** that accept M10 bolts or screws, and four mounting points **B** that accept standard camlock quarter-turn fasteners. The camlock center-to-center distance is 90 mm (3.54 in.).

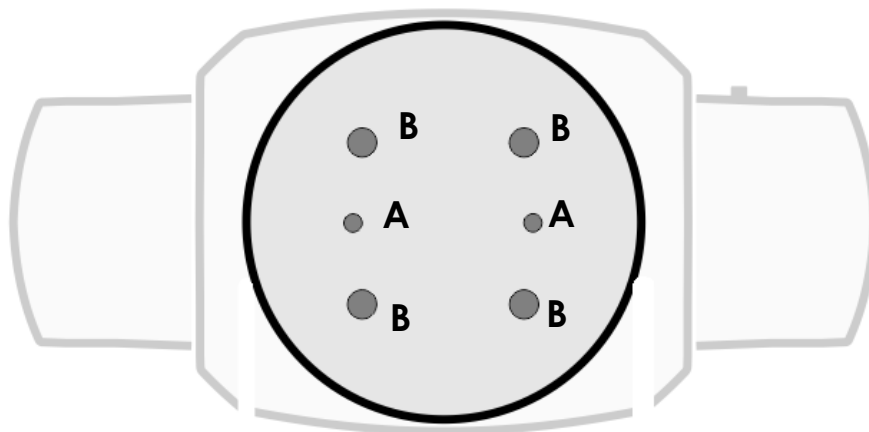

Figure 8. Mounting points in base

Mounting with rigging clamps

To install the impression E350 in any orientation on a rigging truss or similar support:

1. See Figure 9. Pass two M10 grade 8.8 steel bolts or screws through two half-coupler type rigging clamps and check that the bolts will protrude minimum 9 mm / 0.35 in. and maximum 11 mm / 0.43 in. into the base of the fixture when tightened.
2. See Figure 8. Fasten the bolts through the half-coupler clamps and into holes **A** in the base of the fixture so that the clamps are held securely.
3. Fasten the rigging clamps securely around a chord on a rigging truss or similar bar.
4. Secure the fixture with a safety cable as described in 'Safety attachment' on page 20.
5. Make sure that the head will not collide with another fixture or any other object when it moves through its full pan and tilt ranges.

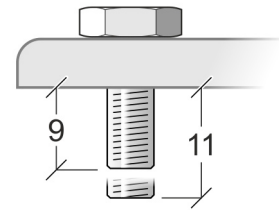

Figure 9. Min./max. bolt protrusion into base (millimeters)

Safety attachment

If the impression E350 may cause injury or damage if it falls, you must secure it with a secondary attachment such as a safety cable. To install a safety cable:

1. Obtain a safety cable that is approved for the load it will secure.
2. See Figure 10. Fasten the safety cable to one of the safety cable attachment points in the base of the fixture and loop it around a secure anchoring point such as a truss chord. Remove as much slack as possible in the safety cable (by looping it more than once around the truss chord, for example).
3. Secure the safety cable and check that it will hold the fixture if a primary attachment fails.



Figure 10. Safety cable attachment points in base of fixture

Placing on a surface

If you install the supplied tripod on the base of the fixture, you can stand the impression E350 upright on a flat, stable, horizontal surface in any location where the fixture is not accessible to the public and will not present any safety risks.

If necessary to prevent the fixture from moving or falling, pass a ratchet strap, webbing or other suitable bracing strap through the safety cable attachment points in the base (see Figure 10) or the strap attachment points in the tripod stand (see Figure 11) and fasten it to secure anchoring points. Make sure that the strap is tight enough to hold the fixture, but do not distort attachment points by overtightening the strap.

If the fixture may cause injury or damage if it falls, secure it with a safety cable as described in 'Safety attachment' on page 20.

Make sure that the head will not collide with anything when it tilts and rotates.

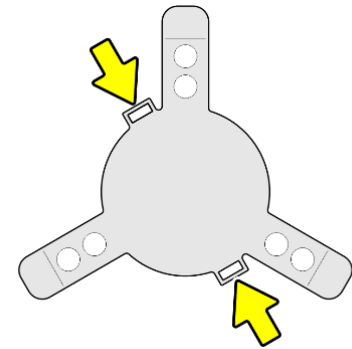

Figure 11. Strap attachment points in tripod stand

Connecting to power

The AC mains power supply must include a connection to ground / protective earth. It must be protected against ground / earth leakage and overload. The auto-sensing power supply accepts AC power at 100-240 V, 50/60 Hz. Do not connect the fixture to power at any other voltage or to an external dimmer.

The impression E350 has a 3-conductor Neutrik powerCON TRUE1 socket that accepts AC power from a Neutrik powerCON TRUE1 female cable connector.

Although powerCON TRUE1 connectors support hot-plugging, it is still good practice to shut down power to power cables or move Power ON/OFF switches to OFF before connecting power cables to fixtures.

To connect the fixture to power:

1. Check that power to the power input cable is shut down or that the fixture's power switch is set to OFF.
2. See **Q** in Figure 2 on page 11. Note the position of the keys and keyways on the power cable connector and *Mains In* socket and align them with each other. Insert the cable connector into the socket and twist clockwise to lock.
3. Before applying power by energizing the power cable and/or switching on the power switch, check that the head is unlocked and can move freely and check that nobody is looking directly into the front of the fixture.

Installing power connectors

It is possible to install a cord cap / mains power plug that is suitable for your local convenience receptacles / power sockets on the supplied power input cable. If you do this, check that the cord cap / plug is rated minimum 250 V, 16 A, that it has a connection to ground / earth and that it has an integral cable grip. Follow the cord cap / plug manufacturer's assembly instructions.

If you need to install a Neutrik powerCON TRUE1 connector on a power cable, follow the instructions given in the Support area of the Neutrik website at www.neutrik.com.

Respect the color coding used in the supplied power cable and in your local mains power wiring system. US and EU systems use the color coding shown below:

	Live or L	Neutral or N	Ground / Earth or ⊕
US system	Black	White	Green
EU system	Brown	Blue	Yellow/green

Main fuse

See Figure 12. The main fuse sits in a holder in the base.

If the fixture appears to be completely shut down even though power is applied, the main fuse may have blown. Disconnect the fixture from power before replacing the fuse. You can open the fuseholder with a flat-headed screwdriver. Replace only with a fuse of the same type and rating.

If the fuse blows repeatedly, disconnect the fixture from power and contact GLP for service and repair.

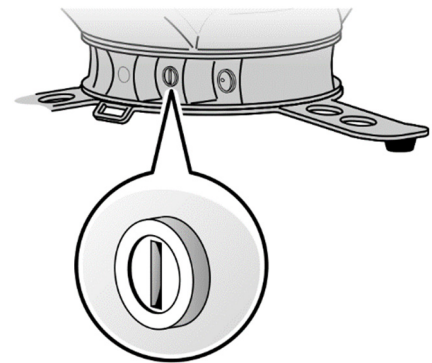

Figure 12. Main fuse

Connecting to a DMX control data link

The impression E350 provides 5-pin and 3-pin XLR IN and THRU sockets for connection to a USITT DMX512 data link.

Connectors use standard DMX pinout:

- Pin 1 = Ground
- Pin 2 = Negative / data cold
- Pin 3 = Positive / data hot.
- Pins 4 and 5 are not used.

If you would like any advice with planning and installing a DMX link, your GLP supplier will be happy to provide assistance.

6. Control menus and LCD display



Warning! DMX control is disabled when the control menus are active. Be prepared for the head to move as soon as you exit the control menus.

The control panel and LCD display provide access to user settings, readouts, and utilities.

When power is applied, the fixture resets and **impression E350** appears in the display panel. After the reset has completed, the main menu is displayed:



Figure 13. Control panel

See Figure 13. From left to right, the top line of the main menu displays:

- Main CPU software version
- Pan, tilt, and zoom modes: **N** (Normal) or **I** (inverse)
- Dimming curve: **L** (Linear) or **E** (Extra Soft)
- PWM frequency.

In the example shown in Figure 13:

- The fixture is running CPU software version 0.12
- Pan, Tilt and Zoom are Normal
- Dimming is Extra-soft
- The current PWM frequency is 3000 Hz
- The fixture's DMX start address is 101, it uses DMX channels 101 – 127, and DMX channel 128 is available for use as the start address of the next device on the DMX link.

A flashing display indicates loss of DMX.

To use the control panel:

- Use the **Jog wheel** to scroll up and down through menu options.
- Press the **Enter** button to select a setting, confirm a command or enter a submenu.
- Press the **Mode** button to escape and return to the top of the menu.

7. Control menu layout

DMX Start Address	1 - 512	Set DMX start address	
Special	Set Dimming Mode	Esoft	Select dimming curve: Extra Soft / Linear
		Lin	
	Show Errors	Execute	Display any stored errors
	No DMX	Blackout	Fixture blacks out if DMX signal stops
		Hold	Fixture continues to display current effect if DMX signal stops
		Stand-Alone	Fixture displays its stand-alone scene if DMX signal stops
		DMX Shot	Fixture stores the scene it is currently displaying as its stand-alone scene
	Set PWM Frequency	2200 Hz	Set PWM frequency
		3000 Hz	
		4800 Hz	
		9600 Hz	
		25 000 Hz	
	Focus Tracking Mode	OFF	Set zoom / focus tracking distance
		Near	
		Medium	
Far			
Shortcut	ON	Effect wheel shortcuts (pass through open)	
	OFF		
Set Fan Mode	Regulated (REG)	Fan speed temperature-regulated	
	Low	Fan speed constant: low / medium / high	
	Medium		
	High		

Special (continued)	Set Display Mode	Normal (NORM)	Onboard display panel sleeps after 30 seconds
		ON	Onboard display panel constantly on
		OFF	Onboard display panel constantly off
	Default	Execute	Return fixture to factory default settings
	Temperature LED	XXX°	LED PCB temperature
	Temperature main	XXX°	Main PCB temperature
	Temperature base	XXX°	Base PCB temperature
	Boot count	XXX	Number of startups since manufacture (non-resettable)
	Fixture hours	XXX	Operating hours since manufacture (non- resettable)
	Version Infos	Main	Fixture firmware version
		Artnet/WDMX	Art-Net / WDMX driver version
		LED Driver	Driver versions
		Color Driver	
		Head Driver	
Effect Driver			
Pan Driver			
Tilt Driver			
Main Fan Driver			
LED Fan Driver			
Color Fan Driver			

Special (continued)	Adjust	Key code → Enter value	Pan Offset	Set adjustment offset values
			Tilt Offset	
			Zoom Offset	
			Focus Offset	
			Prism Position offs.	
			Frost offset	
			RotGob Pos. Offset	
			RotGob Pos. Compens	
			RotGob Rot. Offset	
			EffectWhl Pos. Offs.	
			FixGobo offset	
			ColorWheel offset	
			Cyan Offset	
			Cyan Offset fine	
			Magenta Offset	
			Magenta Offset fine	
Yellow Offset				
Yellow Offset fine				
Iris Offset				
Display Invert	ON / OFF		Invert onboard display	
Position Feedback	ON / OFF		Enable/Disable Pan/Tilt position feedback	
Reverse Pan	ON / OFF		Invert Pan	
Reverse Tilt	ON / OFF		Invert Tilt	
Reverse Zoom	ON / OFF		Invert Zoom from Wide → Spot to Spot → Wide	
Reset Pan/Tilt only	ON / OFF		Reset Pan and Tilt	
Reset head only	ON / OFF		Reset effects and processes in head	
Reset	ON / OFF		Reset entire fixture	



Default values are shown **in bold type**.









User-settable values are displayed in grey boxes.







8. DMX channel layout

Normal mode (27 DMX channels)

Channel	Function	Description	DMX range	Default DMX	% Range	Fade
1	Pan coarse	Left – right in 1.2° increments (16 bit)	0 – 65535	32767	0 – 100%	Fade
2	Pan fine					
3	Tilt coarse	Up – down in 1.2° increments (16 bit)	0 – 65535	32767	0 – 100%	Fade
4	Tilt fine					
5	Color wheel	Open – White 7500 K	0 – 3	0	0 – 1.2%	Snap
		Color 01 – Congo blue (UV)	4 – 7		1.6 – 2.7%	Snap
		Color 02 – Green	8 – 11		3.1 – 4.3%	Snap
		Color 03 – Orange	12 – 15		4.7 – 5.9%	Snap
		Color 04 – Magenta	16 – 19		6.3 – 7.5%	Snap
		Color 05 – Blue	20 – 23		7.8 – 9.0%	Snap
		Color 06 – CTC 1	24 – 27		9.4 – 10.6%	Snap
		Color 07 – CTC 2	28 – 31		11.0 – 12.2%	Snap
		Color 08 – CTC 3	32 – 35		12.5 – 13.7%	Snap
		Color 09 – Minus green	36 – 39		14.1 – 15.3%	Snap
Color 10 – Red	40 – 43	15.7 – 16.9%	Snap			
	Color wheel indexing 0 – 360° (continuous color changing)	44 – 167	17.3 – 65.5%	Fade		
	Color wheel rotation CW fast – slow	168 – 211	65.9 – 82.7%	Fade		
	Color wheel rotation stop	212	83.1%	Snap		
	Color wheel rotation CCW slow – fast	213 – 255	83.5 – 100%	Fade		
6	Cyan	Cyan 0 – 100%	0 – 255	0	0 – 100%	Fade
7	Magenta	Magenta 0 – 100%	0 – 255	0	0 – 100%	Fade
8	Yellow	Yellow 0 – 100%	0 – 255	0	0 – 100%	Fade
9	CTC	Off (default: 7500 K)	0 – 31	0	0 – 12.2%	Snap Fade
		8000 K	32 – 35		12.5 – 13.7%	
		7900 K	36 – 39		14.1 – 15.3%	
		7800 K	40 – 43		15.7 – 16.9%	
		7700 K	44 – 47		17.3 – 18.4%	
		7600 K	48 – 51		18.8 – 20.0%	
		7500 K	52 – 55		20.4 – 21.6%	
		7400 K	56 – 59		22.0 – 23.1%	
		7300 K	60 – 63		23.5 – 24.7%	
		7200 K	64 – 67		25.1 – 26.3%	
		7100 K	68 – 71		26.7 – 27.8%	
		7000 K	72 – 75		28.2 – 29.4%	
		6900 K	76 – 79		29.8 – 31.0%	
		6800 K	80 – 83		31.4 – 32.5%	
		6700 K	84 – 87		32.9 – 34.1%	
		6600 K	88 – 91		34.5 – 35.7%	
		6500 K	92 – 95		36.1 – 37.3%	
		6400 K	96 – 99		37.6 – 38.8%	
		6300 K	100 – 103		39.2 – 40.4%	
		6200 K	104 – 107		40.8 – 42.0%	
6100 K	108 – 111	42.4 – 43.5%				
6000 K	112 – 115	43.9 – 45.1%				
5900 K	116 – 119	45.5 – 46.7%				

9 continued		5800 K	120 – 123		47.1 – 48.2%	Fade
		5700 K	124 – 127		48.6 – 49.8%	
		5600 K	128 – 131		50.2 – 51.4%	
		5500 K	132 – 135		51.8 – 52.9%	
		5400 K	136 – 139		53.3 – 54.5%	
		5300 K	140 – 143		54.9 – 56.1%	
		5200 K	144 – 147		56.5 – 57.6%	
		5100 K	148 – 151		58.0 – 59.2%	
		5000 K	152 – 155		59.6 – 60.8%	
		4900 K	156 – 159		61.2 – 62.4%	
		4800 K	160 – 163		62.7 – 63.9%	
		4700 K	164 – 167		64.3 – 65.5%	
		4600 K	168 – 171		65.9 – 67.1%	
		4500 K	172 – 175		67.5 – 68.6%	
		4400 K	176 – 179		69.0 – 70.2%	
		4300 K	180 – 183		70.6 – 71.8%	
		4200 K	184 – 187		72.2 – 73.3%	
		4100 K	188 – 191		73.7 – 74.9%	
		4000 K	192 – 195		75.3 – 76.5%	
		3900 K	196 – 199		76.9 – 78.0%	
		3800 K	200 – 203		78.4 – 79.6%	
		3700 K	204 – 207		80.0 – 81.2%	
		3600 K	208 – 211		81.6 – 82.7%	
		3500 K	212 – 215		83.1 – 84.3%	
		3400 K	216 – 219		84.7 – 85.9%	
		3300 K	220 – 223		86.3 – 87.5%	
	3200 K	224 – 227		87.8 – 89.0%		
	3100 K	228 – 231		89.4 – 90.6%		
	3000 K	232 – 235		91.0 – 92.2%		
	2900 K	236 – 239		92.5 – 93.7%		
	2800 K	240 – 243		94.1 – 95.3%		
	2700 K	244 – 247		95.7 – 96.9%		
	2600 K	248 – 251		97.3 – 98.4%		
	2500 K	252 – 255		98.8 – 100%		
10	Gobo wheel 1 gobo selection	Open	0 – 15	0	0 – 5.9%	Snap
		Gobo 01	16 – 31		6.3 – 12.2%	
						
		Gobo 02	32 – 47	12.5 – 18.4%		
						
Gobo 03	48 – 63	18.8 – 24.7%				
						

10 continued		Gobo 04 	64 – 79		25.1 – 31%	Snap
		Gobo 05 	80 – 95		31.4 – 37.3%	
		Gobo 06 	96 – 111		37.6 – 43.5%	
		Gobo 07 	112 – 127		43.9 – 49.8%	
		Gobo wheel rotation stop	128		50.2%	
		Gobo wheel rotation CW fast – slow	129 – 191		50.6 – 74.9%	Fade
		Gobo wheel rotation stop	192		75.3%	Snap
		Gobo wheel rotation CCW slow – fast	193 – 255		75.7 – 100%	Fade
11	Gobo wheel 1 index & rotation	Gobo index 0 – 360°	0 – 32767	0	0 – 50.0%	Fade
12		Gobo rotation CW fast – slow	32768 – 49151		50.0 – 74.9%	Fade
		Gobo rotation stop	49152		75%	Snap
	Gobo rotation CCW slow – fast	49153 – 65535		75.1 – 100%	Fade	
13	Gobo wheel 2 (fixed gobos) gobo selection	Open	0 – 7	0	0 – 2.7%	Snap
		Gobo 01 	8 – 15		3.1 – 5.9%	
		Gobo 02 	16 – 23		6.3 – 9.0%	
		Gobo 03 	24 – 31		9.4 – 12.2%	
		Gobo 04 	32 – 39		12.5 – 15.3%	

13 continued		Gobo 05 	40 – 47		15.7 – 18.4%	Snap
		Gobo 06 	48 – 55		18.8 – 21.6%	
		Gobo 07 	56 – 63		22.0 – 24.7%	
		Gobo 08 	64 – 71		25.1 – 27.8%	
		Gobo 09 	72 – 79		28.2 – 31%	
		Gobo 10 	80 – 87		31.4 – 34.1%	
		No function	88 – 127		34.5 – 49.8%	
		Gobo wheel rotation stop	128		50.2%	Snap
		Gobo wheel rotation CW fast – slow	129 – 191		50.6 – 74.9%	Fade
		Gobo wheel rotation stop	192		75.3%	Snap
Gobo wheel rotation CCW slow – fast	193 – 255		75.7 – 100%	Fade		
14	Shutter	Closed	0 – 15	255	0 – 5.9%	Snap
		Pulse, random, slow – fast	16 – 47		6.3 – 18.4%	Fade
		Ramp-up, random, slow – fast	48 – 79		18.8 – 31%	
		Ramp-down, random, slow – fast	80 – 111		31.4 – 43.5%	
		Ramp-up-down, random, slow – fast	112 – 143		43.9 – 56.1%	
		Strobe with b/o pause 5 – 0.1 sec.	144 – 199		56.5 – 78.0%	
		Strobe 1 – 10 Hz	200 – 239		78.4 – 93.7%	
		Open	240 – 255		94.1 – 100%	Snap

15	Dimmer coarse	Intensity 0 – 100%	0 – 65535	32768	0 – 100%	Fade
16	Dimmer fine					
17	Focus coarse	Near – far	0 – 65535	32768	0 – 100%	Fade
18	Focus fine					
19	Zoom	Wide – narrow	0 – 255	128	0 – 100%	Fade
20	Frost	No frost	0 – 3	0	0 – 1.2%	Snap
		Frost light 0 – 100%	4 – 127		1.6 – 49.8%	Fade
		Frost heavy 0 – 100%	128 – 255		50.2 – 100%	
21	Prism	No prism	0 – 7	0	0 – 2.7%	Snap
		Prism rotation CW fast - slow	8 – 130		3.1 – 51%	Fade
		Prism rotation stop	131		51.4%	Snap
		Prism rotation CCW slow – fast	132 – 255		51.8 – 100%	Fade
22	Effect wheel position	Effect wheel out – in – tilt 0 - 90°	0 – 255	0	0 – 100%	Fade
23	Effect wheel index/rotation	Effect wheel rotation stop	0	0	0%	Snap
		Effect wheel rotation CW fast – slow	1 – 127		0.4 – 49.8%	Fade
		Effect wheel rotation stop	128		50.2%	Snap
		Effect wheel rotation CCW slow – fast	129 – 255		50.6 – 100%	Fade
24	Iris	Open – closed	0 – 255	0	0 – 100%	Fade

25	Special / Control	No function	0 – 38	0	0 – 14.9%	Snap
		Dimmer curve extra soft*	39 – 41		15.3 – 16.1%	
		Dimmer curve linear*	42 – 44		16.5 – 17.3%	
		No function	45 – 53		17.6 – 20.8%	
		Display off*	54 – 56		21.2 – 22%	
		Display auto-off*	57 – 59		22.4 – 23.1%	
		Display on*	60 – 62		23.5 – 24.3%	
		Display orientation normal*	63 – 65		24.7 – 25.5%	
		Display orientation invert*	66 – 68		25.9 – 26.7%	
		No function	69 – 71		27.1 – 27.8%	
		No DMX = blackout*	72 – 74		28.2 – 29.0%	
		No DMX = hold*	75 – 77		29.4 – 30.2%	
		No DMX = stand-alone*	78 – 80		30.6 – 31.4%	
		No DMX = DMX shot*	81 – 83		31.8 – 32.5%	
		No function	84 – 86		32.9 – 33.7%	
		Fan regulated*	87 – 89		34.1 – 34.9%	
		Fan high*	90 – 92		35.3 – 36.1%	
		Fan medium*	93 – 95		36.5 – 37.3%	
		Fan low*	96 – 98		37.6 – 38.4%	
		No function	99 – 104		38.8 – 40.8%	
		Position feedback off*	105 – 107		41.2 – 42.0%	
		Position feedback on*	108 – 110		42.4 – 43.1%	
		Effect shortcuts off*	111 – 113		43.5 – 44.3%	
		Effect shortcuts on*	114 – 116		44.7 – 45.5%	
		Tilt invert off*	117 – 119		45.9 – 46.7%	
		Tilt invert on*	120 – 122		47.1 – 47.8%	
		Pan invert off*	123 – 125		48.2 – 49.0%	
		Pan invert on*	126 – 128		49.4 – 50.2%	
		Zoom invert off*	129 – 131		50.6 – 51.4%	
		Zoom invert on*	132 – 134		51.8 – 52.5%	
		Focus tracking off*	141 – 143		55.3 – 56.1%	
Focus tracking near*	144 – 146	56.5 – 57.3%				
Focus tracking medium*	147 – 149	57.6 – 58.4%				
Focus tracking far*	150 – 152	58.8 – 59.6%				
No function	153 – 191	60.0 – 74.9%				
PWM 2200 Hz **	192 – 194	75.3 – 76.1%				
PWM 3000 Hz **	195 – 197	76.5 – 77.3%				
PWM 4800 Hz **	198 – 200	77.6 – 78.4%				
PWM 9600 Hz **	201 – 203	78.8 – 79.6%				
No function	204 – 206	80.0 – 80.8%				
PWM 25 kHz **	207 – 209	81.2 – 82.0%				
No function	210 - 239	82.4 – 93.7%				
Set fixture to factory defaults**	240 – 242	94.1 – 94.9%				
No function	243 – 245	95.3 – 96.1%				
Reset pan/tilt *	246 – 248	96.5 – 97.3%				
Reset head*	249 – 251	97.6 – 98.4%				
Reset all*	252 – 255	98.8 – 100%				

26	FX1 selection	No FX	0 – 10	0	0 – 3.9%	Snap
		Chaser 1-2-3-4-3-2-1	11 – 14		4.3 – 5.5%	
		Crossfade 1-2-3-4-3-2-1	15 – 18		5.9 – 7.1%	
		Chaser 1+2 – 3+4	19 – 22		7.5 – 8.6%	
		Crossfade 1+2 – 3+4	23 – 26		9 – 10.2%	
		Chaser 1+4 – 2+3	27 – 30		10.6 – 11.8%	
		Crossfade 1+4 – 2+3	31 – 34		12.2 – 13.3%	
		Chaser random	35 – 38		13.7 – 14.9%	
		Crossfade random	39 – 42		15.3 – 16.5%	
		No function	43 – 255		16.9 – 100%	
27	FX1 adjustment	FX1 speed slow – fast	0 – 255	0	0 – 100%	Fade

* Move from zero and hold value for 3 seconds to apply

** Move from zero and hold value for 5 seconds to apply

Notes:

Percentage values are calculated by dividing DMX values by 2.56 and rounding to the nearest 0.1%.

To apply a command on Channel 25 (Special / Control), start at a value of zero, then move to the required value and hold it for the required time (e.g. 3 seconds). If you move to the required value from any other value than zero, the command will not be applied.

To adjust the PWM frequency using the Special / Control channel, start at a value of zero, move to the required value and hold it for at least 5 seconds.

Default settings are written in **bold type**.

9. Troubleshooting

The checklist below may help you troubleshoot in the unlikely event that a problem occurs while using the product.

Symptom	Possible cause	Suggested action
No response from fixture.	No power to fixture.	Check that power is turned on. Check cables and connections.
	Fuse blown or internal fault.	Contact GLP Service or authorized service partner. Do not remove base or yoke covers. Do not attempt to replace a fuse or carry out any repairs or service that are not described in this User Manual unless you have both authorization from GLP and official GLP service documentation.
Fixture resets correctly but does not respond (or does not respond correctly) to the controller.	Bad data link.	Inspect connections and cables. Correct poor connections. Repair or replace damaged cables.
	Data link not terminated.	Insert DMX termination plug in data output socket of last fixture on data link.
	Incorrect fixture addressing.	Check fixture address and DMX mode settings.
	A fixture is defective and is disturbing data transmission on the link.	Unplug DMX IN and THRU connectors and connect them directly together to bypass one fixture at a time until normal operation is regained. Have defective fixture serviced by an authorized technician.
Error after fixture reset.	Effect requires mechanical adjustment.	Check fixture's software version and error messages for more information. Contact GLP Service or authorized GLP service partner.
Mechanical effect loses position.	Mechanical train requires cleaning, adjustment, or lubrication.	Check fixture's software version and error messages for more information. Contact GLP Service or authorized GLP service partner.
Light output cuts out intermittently.	Fixture too hot.	Allow fixture to cool. Reduce ambient temperature. Ensure free airflow around fixture. Clean fixture if necessary.

10. Caring for your product

Cleaning

The buildup of dust, dirt and other airborne particles will reduce the fixture's light output. It will also prevent the fixture from cooling correctly, and this will reduce the fixture's lifetime. The rate of dirt buildup will vary depending on environmental factors such as airborne dust, use of smoke machines, airflow from ventilation systems, etc. The fixture's cooling fans will accelerate buildup, and any smoke particles that are present in the atmosphere will increase the tendency for dirt to clog.

To get the best performance and lifetime from the fixture, inspect it regularly and clean it as soon as you see signs of dirt buildup. Assess the operating environment each time you begin to use the fixture. In dusty or smoky conditions, inspect the fixture after a few hours and check it frequently – the fixture may attract dirt faster than you expect. Draw up a cleaning schedule that will make sure that dirt is removed before it can build up.

Use the following guidelines:

- Disconnect the fixture from power and allow it to cool completely before cleaning.
- Do not use solvents, abrasives or any other aggressive product to clean the fixture.
- Vacuum or use low-pressure compressed air to remove dust and loose particles from surfaces and air vents. Prevent the blades of cooling fans from turning before you aim a vacuum or air jet at the fan, or you may spin the fan too fast and damage it.
- Clean glass components by wiping gently with a soft, clean, lint-free cloth moistened with a weak detergent solution. Put the solution on the cloth, not on the surface to be cleaned. Avoid rubbing glass surfaces. If particles are stuck to the glass, try to lift them off by dabbing them repeatedly with a cotton swab or moistened lint-free cloth.
- Dry the fixture with a soft, clean, lint-free cloth or low-pressure compressed air before reapplying power.

Lubrication

The fixture does not normally need lubrication. If any moving parts show signs of rough movement, consult a GLP service partner.

11. Technical specifications

Light source

LED type: 350 W white (7500 K) LED engine
LED lifetime: >20 000 hours (to >70% luminous output)

Optics

Luminous flux: 9750 – 12 200 lumens
Minimum zoom angle (3% cutoff): 8.5°
Maximum zoom angle (3% cutoff): 42°
Zoom range: 5:1

Effects

Color mixing: CMY, independently variable 0-100% continuous
Color wheel: 10 x colors (including 3 x CTC and Minus Green as standard) plus open, adjustable via CMY
CTC continuous: 2500 – 8000 K continuously variable
Gobo wheel 1: 7 x interchangeable rotating gobos (26.9/21.5 mm) + open, gobo indexing and rotating, wheel rotation
Gobo wheel 2: 10 x fixed gobos + open, wheel rotation
Prism: 8-facet, rotating
Iris: Motorized
Frost: 2-way-frost-filter (soft / heavy)
Animation effects: Rotating animation wheel, 0 - 90° indexable wheel angle
Dimmer: 0-100% continuous, electronic 16-bit, choice of two dimming curves
Shutter/strobe: Instant open and blackout, pulse and strobe effects up to 10 Hz, electronic
Variable PWM frequency
Pre-programmed effects: FX channel with LED engine FX etc.
Zoom: 8.5° - 42° with focus tracking

Movement

Resolution: 8 / 16 bit
Positional feedback: Yes
Pan range: 640°
Tilt range: 262°

Control

Control systems: DMX, RDM
Onboard interface: Battery-powered control panel with backlit graphic display
DMX channels: 27
16-bit control: Dimming, focus, gobo indexing, gobo rotation, pan and tilt
DMX compliance: USITT DMX512-A
RDM compliance: ANSI/ESTA E1.20
Transceiver: RS-485
Receiver: Opto-isolated RS-485
Wireless DMX: Optional via Lumenradio CRMX PCB plugin
Art-Net (in preparation): EtherCon

Fixture software update: Via DMX link or RJ-45
Standalone: DMX 'snapshot' recorded via DMX, can auto start at power on

Installation

Orientation: Any
Location: Dry location only, fastened to surface or structure or free standing on supplied tripod floor stand
Mounting points: 4 x camlock fastener points, 2 x M10 threaded holes
Eyelets in fixture base for safety cable attachment
Minimum distance to illuminated surfaces: 2.0 m (6.6 ft.)
Minimum distance to combustible materials: 0.2 m (8 in.)

Connections

AC mains power in: Neutrik powerCON TRUE1
DMX and RDM data in and out (thru), firmware upload: 5-pin XLR
Art-Net, firmware upload: EtherCon

Electrical

AC power: 100-240 V, 50/60 Hz
Maximum power consumption @230 V: 550 W
Minimum power consumption (all effects static, zero light output): 80 W typical
Primary fuse: 20 mm T 5A
EEC (Energy Efficiency Class): D
EEI (Energy Efficiency Index): 1.193
Energy consumption (kWh/1 000 h): 68

Thermal

Cooling: Combined convection and temperature-regulated forced air
Cooling management: Four fan operation modes
Thermal protection system
Maximum surface temperature: 55° C / 131° F
Maximum ambient temperature: 45° C / 115° F
Minimum ambient temperature: 5° C / 41° F

Construction

Color: Black (standard)
Housing material: Impact-resistant flame-retardant thermoplastic
Ingress protection rating: IP20

Rotating gobos

Gobo diameter: 26.9 mm / 1.059 in.
Max. image diameter: 21.5 mm / 0.846 in.
Gobo thickness: 1.1-1.4 mm / 0.043-0.055 in.
Material: Borosilicate 3.3 or better with dichroic or heavy matted aluminum coating

Included items

Power cable (depending on region):

- US power cable: 16 A, 14 AWG, UL listed, E304117, SJT, 4.9 ft.
- EU power cable: 16 A, 1.5mm², H05VV-F, 1.5 m

Detachable tripod floor stand

Shipping options

Single product: Cardboard packing case

Tour packs: 2-fixture flightcase

Dimensions and weight

Depth (head horizontal): 474 mm / 18.8 ins.

Width (across yoke): 471 mm / 18.5 ins.

Height (head vertical): 642 mm / 25.3 ins.

Height (head vertical, with tripod): 672 mm / 26.5 ins.

Weight: 24.5 kg / 54.1 lbs.

12. Dimensions

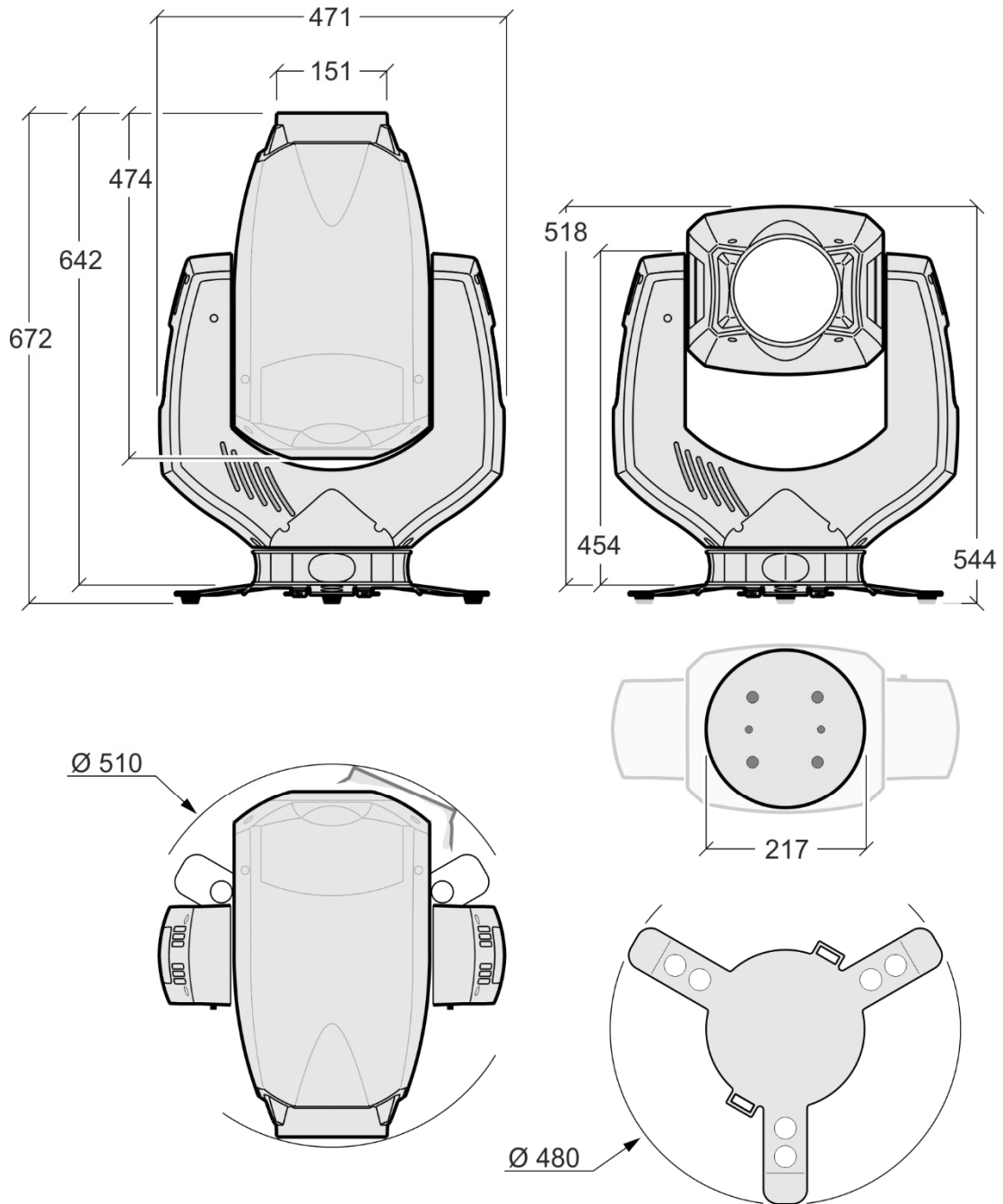

Protecting the environment



GLP products are supplied in compliance with Directive 2012/19/EC of the European Parliament and of the Council of the European Union on WEEE (Waste Electrical and Electronic Equipment), where applicable.

Help preserve the environment. Ensure that this product is recycled at the end of its life. Your supplier can give details of local arrangements for the disposal of GLP products.

This product contains a lithium battery. Ensure that it is disposed of correctly and responsibly by an authorized recycling or waste disposal center at the end of its life. Where applicable, GLP participates in schemes that aim to ensure that local recycling and/or waste disposal centers accept batteries from GLP products.

